

TRV1 SERIES

Thyristor Single-Phase Power Regulator

Instruction Manual

Thank you for purchasing TOHO ELECTRONICS products. Please check that the delivered product is the item you ordered. Please do not begin operating this product until you have read this instruction manual thoroughly and understand its contents.

Notice

Please ensure that this manual is given to the final user of the instrument.

Preface

This instruction manual is meant for those who will be involved in wiring, installation, operation and routine maintenance of the TRV1 Series.

This manual describes the care, installation, wiring, function, and proper procedures regarding the operation of TRV1 Series.

Keep this manual on hand while using this device. Follow the guidance provided herein.

Matters Regarding Safety

For matters regarding safety, potential damage to equipment and/or facilities and additional instructions are indicated as follows:

Ⓒ This heading indicates hazardous conditions that could cause injury or death of personnel. Exercise extreme caution as indicated.

⚠ WARNING

Ⓒ This heading indicates hazardous conditions that could cause damage to equipment and/or facilities. Exercise extreme caution as indicated.

⚠ CAUTION

Ⓒ This heading indicates additional instructions and/or notes.

NOTE

⚠ WARNING

TRV1 Series is designed for controlling power such as heater power in general industrial facilities. It must not be used in any way that may adversely affect safety, health, or working conditions.

⚠ WARNING

- Mount this device on an indoor control panel. Do not touch the charger when using.
 - To avoid electrical shock, turn off electricity during wiring operation.
 - Do not touch the radiant-heat fin because its temperature becomes high when electric current is turned on or even right after it is turned off.
 - To prevent electric shock, earth the ground terminal without fail.
 - Do not touch the terminals or chargers when electric current is turned on.
- Take care not to put metal or other foreign matter inside this device.
When an alien substance is put inside by mistake, cut the power immediately, make sure of safety, and remove the substance.

⚠ CAUTION

To avoid damage to the connected equipment, facilities or the product itself due to a fault of this instrument, safety countermeasures must be taken before usage, such as proper installation of the immediately-cut fuse (option), breaker and overheating protection device.

⚠ CAUTION

- Power supply voltage, load current, and power supply frequency should be within the rated ranges. Wrong usage reduces the life of the product and/or result in problems with the product.
- Voltage different from that of the input specification should not be connected to the control input terminal. It reduces the life of the product and/or result in problems with the product.
- Fasten the screws tightly after wiring has been done. Otherwise, overheat due to contact resistance may result in damage by a fire.
- Put the cover of the terminals on after wiring has been done.
- No modification or irregular usage is allowed.

Symbol Marks used for this product

⚠ Alert symbol mark	This mark is to arouse a user's attention regarding electric shock and high temperature.
⚠ High temperature	This indicates the place (a radiant-heat fin) where the temperature becomes high and may cause a burn.
⚠ Electric shock	This mark is to arouse a user's attention not to touch the chargers when electric current is turned on.
⚠ Ground terminal	Earth the terminals without fail to avoid electric shock.

Guarantee and repair

- The term of a guarantee is restricted to the main part of a product for one year after purchase.
- Within the term of a guarantee, the products will be repaired free if it has broken down after being used properly based on this instruction manual and attached labels.
- Even within the term of a guarantee, the repair is charged in the following cases.
 - (1) Failure or damage due to wrong connections, incorrect usage, or modification.
 - (2) Failure or damage due to transportation, movement, or fall after purchase.
 - (3) Failure or damage due to natural disasters like a fire, earthquake, lightning, or storm/flood disaster, due to environmental conditions such as gas or salt, or due to an abnormal voltage.
- Our company cannot take responsibility about the accident or damage which are caused directly or indirectly due to neglecting warnings or notes of this handling description.
- when repair is needed, please contact the office or agency of our company.

Contents

1. Confirmation of model code and accessories	• • • 1
2. Caution for use	• • • 2
3. Installation	• • • 2
4. Name of each part	• • • 3
5. Wiring	• • • 3
6. Description of screen, function, and operation	• • • 4
7. Auto return function	• • • 6
8. Abnormal detective function	• • • 6
9. Accessory	• • • 6
10. Specification	• • • 7
11. Table of display characters, figures, and alphabet	• • • 8
12. Main causes of trouble and check points	• • • 8

1. Confirmation of model code and accessories

A label of model code is put on the left of the cover of the body.

TYPE :TRV1-M 030	← Model code
No. :0110000001-001	← Manufacture number
INPUT :MULTI	← Input type
100 TO 240 V AC ~	← Power supply voltage
30A 50/60Hz	← Current-carrying capacity
TOHO ELECTRONICS INC. MADE IN JAPAN	Power supply frequency

NOTE: Accessory codes are not printed on the label of model code.

Ⓒ Model Code

TRV1- :Series

M : Input Signal

M: Multi Input I1:4~20mA DC

I2:0~20mA DC

V1: 1~5V DC

V2: 0~5V DC

C1: No-voltage Contact (or Open Collector 5V DC 3mA)

S1: Voltage Pulse (SSR Drive Voltage 12V DC 3mA)

V: Voltage V3: 0~10V DC

030 : Current-carrying Capacity 020:20A, 030:30A, 050:50A, 070:70A, 100:100A, 200:200A

Ⓒ Accessory : Instruction Manual 1 set

※ regarding accessories, refer to Item 9 Accessory (option), page 6.

TOHO ELECTRONICS INC,

TRV1F-2BJ App. - 04

2. Caution for use

- (1) Avoid operating the front panel keys with hard or sharp objects.
Touch the keys lightly with fingertips.
- (2) To clean, wipe gently with a dry cloth. Avoid using solvents such as thinner.

3. Installation

3-1. Installation site (environmental conditions)

CAUTION

Do not use this instrument under the following conditions. Otherwise, the likelihood of fire and/or other dangerous situations is considerable

- (1) Where flammable gas, corrosive gas, oil mist or dust that can deteriorate electrical insulation is generated or is abundant.
- (2) Where the humidity is over 90%RH or where condensation occurs.
- (3) Where highly intense vibration or impact is generated or can affect the operation of the product.
- (4) Where inductive interference, static electricity, magnetism, and noise are likely to be generated.
- (5) Where there are water drops or direct sun light.
- (6) The rated current is 100% in case of the ambient temperature -10~40°C.
In case the temperature is over 40°C, reduce load current according to the following chart.
The operation temperature is 55°C max. In case of the ambient temperature 55°C, load current should be within 80% of the rated current.

Ambient Temperature - Allowable Current Characteristic

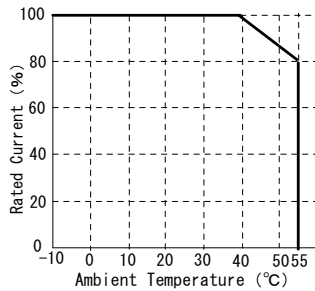

- (7) Where the altitude is above 2,000m.

NOTE: The environmental conditions here comply with the installation category II and the pollution degree 2 set by IEC664.

3-2. Mounting

CAUTION

TRV1 Series has a structure to use after it is fixed on an indoor panel.
Do not use this product on the table/desk or in a non-fixed condition.
Improper usage may result in damage to the product due to fall, electric Shock, and injury. Fix this device on a panel without fail. Make sure to keep people from touching the charger.

- Screw the regulator on the panel by referring to the Set-up Dimension Drawing.
- Prepare screws (Size M5) to fix the regulator on a panel.
- Set the regulator up vertically to enhance a cooling effect with the display section up and the main circuit terminal down.

3-3. Set-up Dimension Drawing

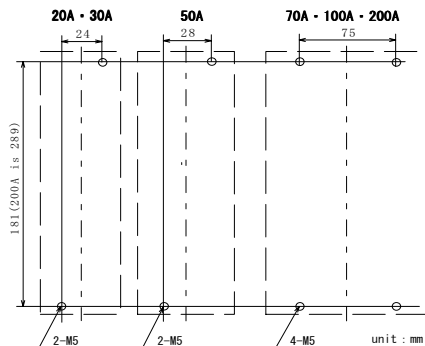

3-4. Set-up Space Drawing

- When two or more TVR1s are mounted or when TVR1 is mounted next to other devices, or when TVR1 is mounted adjacent to the wall, mount them according to the Set-up Space Drawing below to allow a cooling effect.

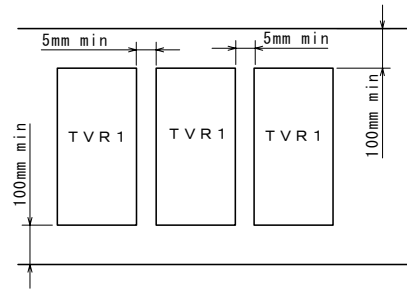

Internal heating value of TVR1 is approximately as follows.

Follow the set-up space and use environment.

Keep in mind that the set-up site needs to be ventilated and the radiated heat needs to be relieved.

Current-carrying capacity	20A	30A	50A	70A	100A	200A
Heating value	24W	40W	56W	79W	109W	260W

3-5. External Dimension Chart

unit : mm

Current	W	H	D	P 1	P 2	P 3
20A	50	192.5	128	24	181	4
30A	50	192.5	128	24	181	4
50A	60	192.5	154	28	181	4
70A	110	192.5	154	75	181	4
100A	155	192.5	154	75	181	4
200A	111	302.5	180	75	289	6

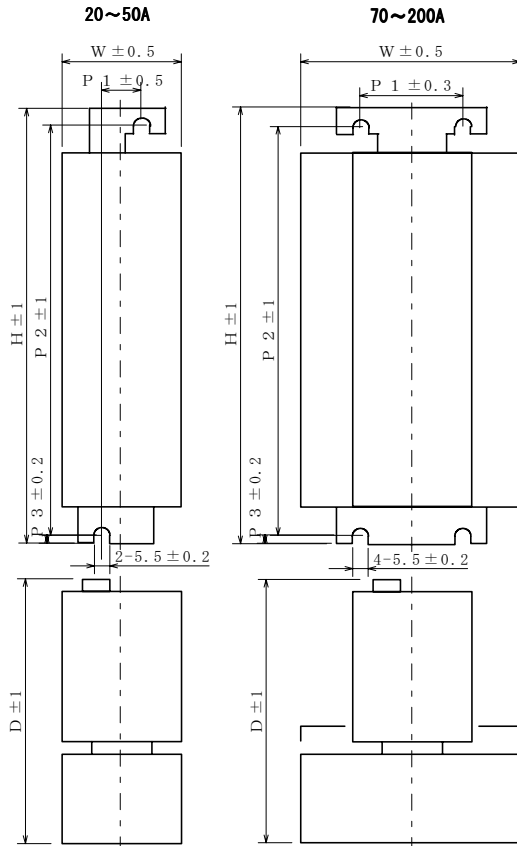

4. Name of Each Part

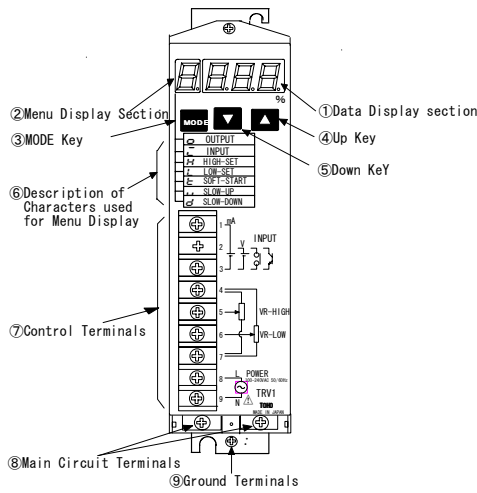

NAME	CONTENT
① Data Display Section	This section displays input values, output values, and setting data
② Menu Display Section	This section displays a character to show what data is displayed
③ MODE Key	This key is used to shift data display screens and to register settings
④ ▲ Up Key	This key is used to increase or move forward set values and settings
⑤ ▼ Down Key	This key is used to reduce or move backward set values and settings.
⑥ Description of Character used for Menu Display	This section shows what the character on the Menu Display means
⑦ Control Terminals	These are the terminals to connect control circuit's input/power supply to an external variable resistor (accessory).
⑧ Main Circuit Terminals	These are the terminals to connect Thyristor element (built-in) to power supply/load
⑨ Ground Terminals	For the safety, earth the terminals at the ground impedance 100Ω or below

5. Wiring

⚠ WARNING

- To prevent electrical shock, turn off electricity during wiring operation.
- Earth the ground terminals without fail.
- Otherwise, there is a possibility of electric shock.
- Avoid touching the wired terminals and chargers while supplying power.

5.1 Wiring of the main circuit terminals and power terminals for control

- ① Use wires with enough capacity to the load current for the main circuit terminal wiring.
- ② Terminal screws for the main circuit should be M5 for 20~50A, and M6 for 70A and 100A, M10 for 200A. Screw tightly by using a proper sticking-by-presser terminal. (Tightening torque: Size M5 2.0~2.4N·m Size M6 2.5~3.0N·m Size M10 10.0~12.0N·m)
- ③ The phase of the main circuit (L1, L2) and control power supply (8, 9) must be the same.

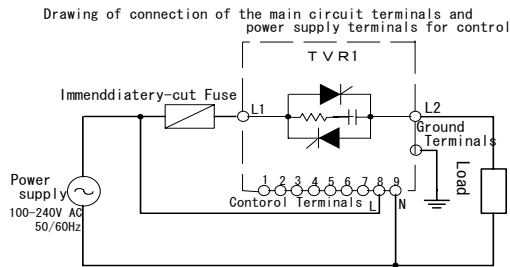

5-2. Wiring of control terminal

① Size M3 screws are used for the control terminal. Please use a sticking-by-pressure terminal with its inside diameter over 3mm and its outside diameter over 6mm. (Tightening torque 0.5~0.6 N·m)

② In wiring control terminals, be careful with polarity (±) and noises from a strong electric circuit.

(1) Wiring of control input signal

● In case of current signal (4~20mA·0~20mA: receiving impedance approx. 100Ω), connect control terminal No.1 (+) with No.3 (-).

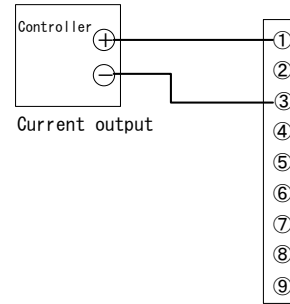

● In case of voltage pulse (1~5V·0~5V: input impedance approx. 500kΩ) or in case of voltage pulse (SSR drive voltage) signal (12V DC 3mA), connect control terminal No. 2 (+) with No.3 (-).

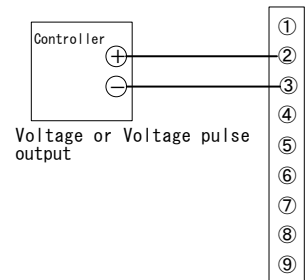

● In case of contact signal (non-voltage) or in case of open collector signal (sink load 5V DC 3mA), connect control terminal No. 2 (+) with No.3 (-). There is no polarity in contact signal.

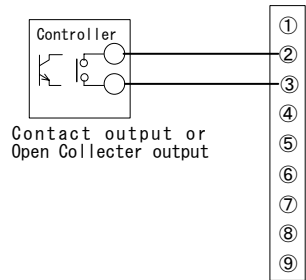

(2) Wiring when an external setting device (accessory) is connected to set grade and lower limit value

● In case of grade setting, connect terminal 4·5·7 with terminal 4·5·7 with terminal No.3·2·1 of the variable resistor and in case of lower limit setting, connect terminal 4·6·7 with terminal No.3·2·1 of the variable resistor.

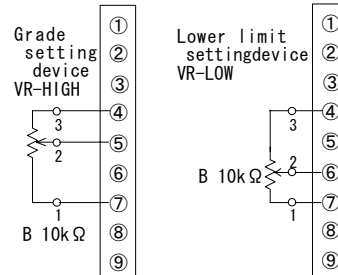

6. Description of screens, functions, and operation

6-1. Power-on and initial screen display

At power-on, each initial screen is successively displayed as below and moves on to the lead screen (monitor of operation volume) of a group of basic screens.

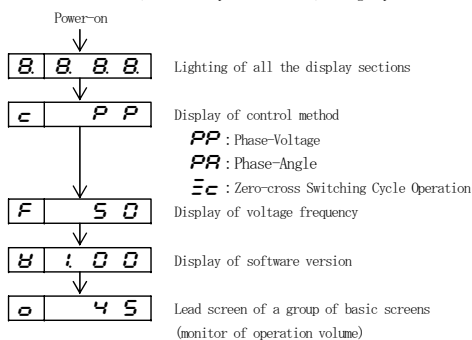

6-2. Description of basic screens

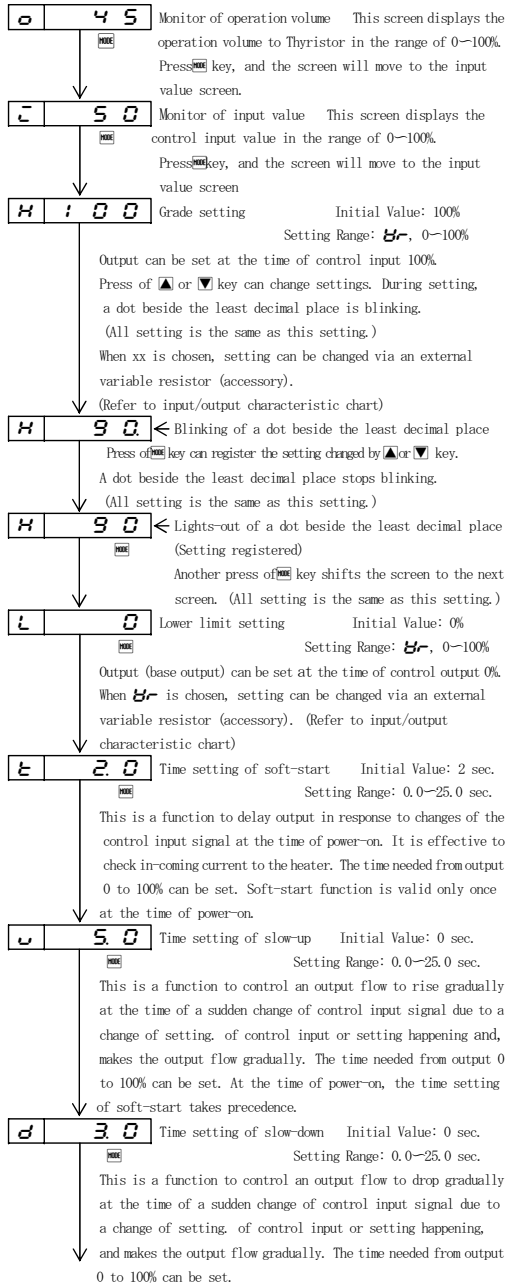

Monitor of operation volume screens

6-3. Input/output characteristic in case of grade or lower limit setting

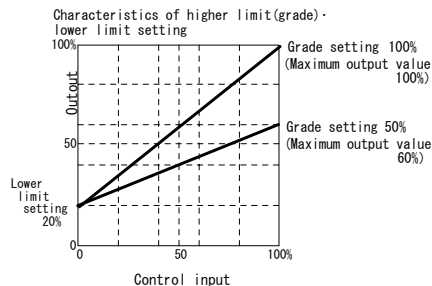
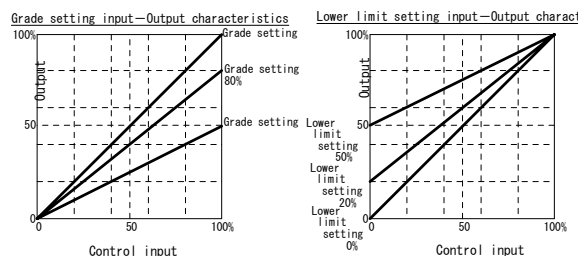

① Lower limit setting is the output value at the time of control input value 0%, that is the base output. Therefore, the formula to calculate the maximum output value in grade setting is as follows:

$$\text{The maximum output value (\%)} = (100 - \text{lower limit set value}) \times \text{grade set value} + \text{lower limit set value}$$

Example: In case of lower set value 20% and grade set value 80%
 The maximum output value = $(100 - 20) \times 80 + 20 = 84\%$

6-4. Time of soft-start, slow up and slow-down

(1) The set time of soft-start, slow-up and slow-down is the time needed from 0% to 100% output. Each grade is fixed and the actual time needed is proportional to a deviation.

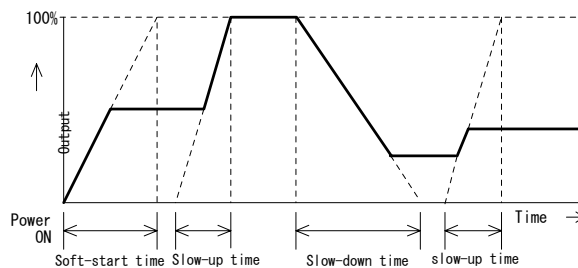

(2) Soft-start function is valid only once at the time of power-on. However, the deviation of input and output at the time of power-on is 0, soft-start operation is not activated. When the deviation of input and output becomes 0 (for example, input drops) while soft-start operation is on, soft-start function is over at that time.

NOTE: Slow-up and slow-down operation restrains a sudden change of load voltage and load current at the time of a sudden change of input or setting. However, in some control systems, this operation may affect the control system.

6-5. Description of setting screens

Press **ESC** key for three seconds on the basic screens and the screen jumps to the control method choice screen, one of the setting screens.

Press **ESC** key for three seconds on the setting screens and the screen jumps to the monitor of operation volume, one of the basic screens.

CAUTION : When control method and input code are changed, turn off the power supply of the main circuit.

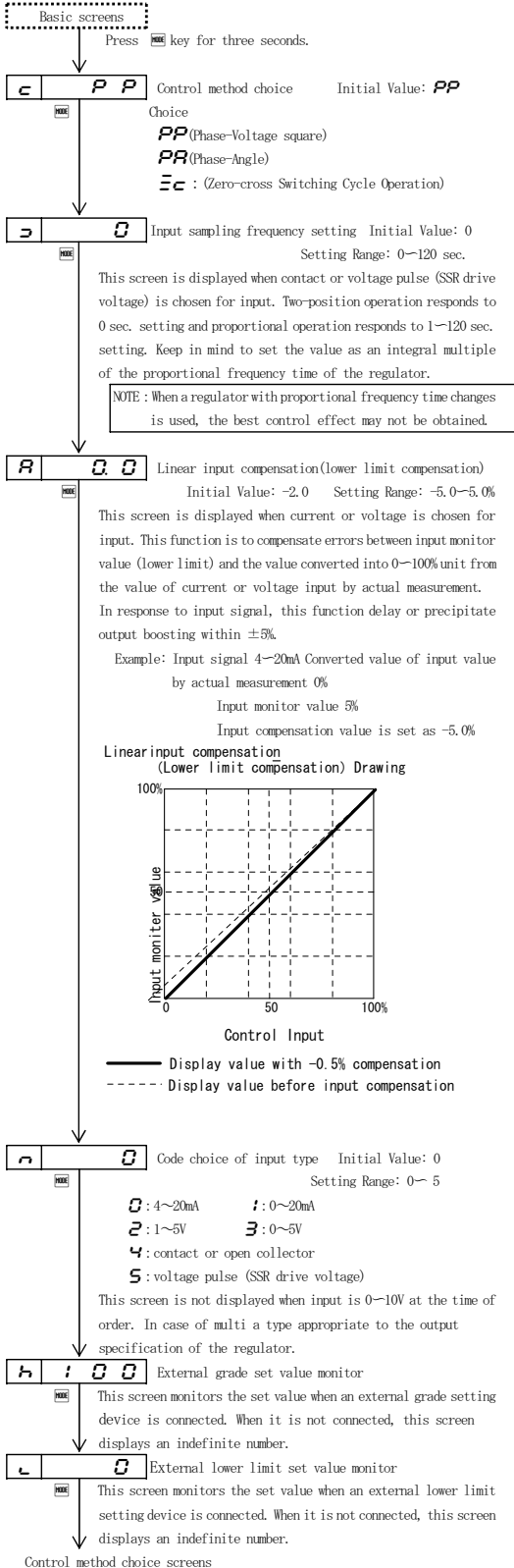

6-6. Description of control method

(1) Phase control

This method is to control power to the load successively by changing the phase angle of AC voltage applied to the load.

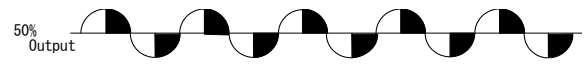

(2) Zero-cross switching control

This method is to control output by turning Thyristor on or off when the voltage becomes 0. As the output is turned on or off at 0V, there is less noise compared to phase control.

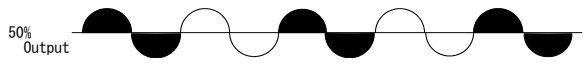

(3) Input/output characteristic of angle control in case of phase control and voltage square control

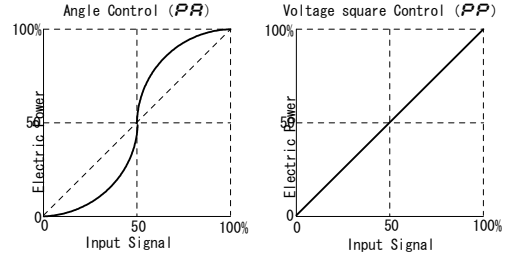

- In case of angle control, in response to input signal, output voltage draws S-shaped curve.
- In case of voltage control, in response to input signal, output draws a mostly straight line, which is voltage proportional. (In case of fixed impedance load)

6-7. Input

- When contact input is chosen, open collector signals also run this regulator. In case of open collector, sink load is 5V DC, 3mA.
- When voltage pulse (SSR drive voltage) is chosen, keep leak current less than 0.1mA or at the time of OFF of this regulator. If it is not possible, connect a bleeder resistor to the output terminal of a controller or to terminal 2-3 of TRV1 so that the residual electric charge of TVR1 control input is less than 0.5V at the time of OFF of this regulator.

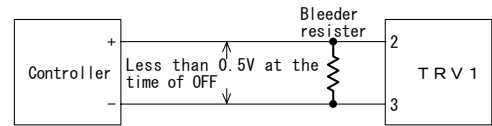

- When more than one TRV1 are connected to one controller, input terminals of TRV1 are connected in series in case of current signal, and in parallel in case of voltage signal.

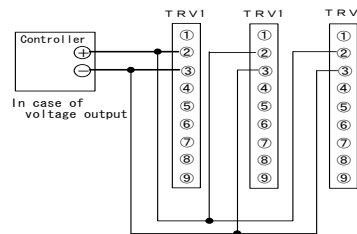
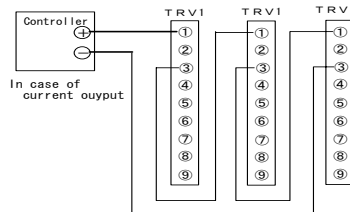

6-8. Operation at the time of power brake down

Operation of TVRI at the time of power brake down is as follows:

- (1) If a power brake down is less than 3 msec, operation is continued.
- (2) When control voltage is 100V, output becomes 0% at 3~60msec. power brake down. When control voltage is 200V, output becomes 0% at 3~120msec. power brake down. In both cases, according to soft-start set time, it goes back to operation status.
- (3) When control voltage is 100V, the system goes to reset status at more than 60msec. power brake down. When control voltage is 200V, the system goes to reset status at more than 120msec. power brake down. In both cases, the operation is resumed just like at a normal power-on.

7. Auto-return function

When there is no key operation for three seconds on the screens other than the output monitor screen, the screen automatically shifts to the output monitor screen. However, if the status is "during setting" (a dot beside the least decimal place is blinking), even when there is no key operation for three seconds, the setting status is continued.

8. Abnormal detective function

8-1. Frequency automatic distinction function

Frequency automatic distinction is made only at the time of power-on. When the frequency is either less than 45Hz or more than 65Hz, the function stops with the value displayed. In this case, there is a possibility of abnormality in power supply or disorder in the unit. Confirm the power supply frequency.

8-2. Abnormal of Cooling Fan (Current capacity 200A only.)

When the system detects the trouble of the fan stopping during an operation, the output is shut down to 0% and **FRn** is shown on the display section.

Once the detection function fan on, the system cannot start again even if the fan recovers. In order to get the system started, fan off the power supply and then turn it on again.

[NOTE : A possible cause of why the fan stops is the accumulation of dust or soot. If the fan itself is broken, contact our agency or us.]

⚠ CAUTION : When you inspect or clean the fan, shut off the power supply so that there can be no accident such as fingers caught between the fan blades or any other kind of injury.]

9. Accessory

9-1. External setting device (variable resistor, knob, and scale)

- Accessory code 021: 1 set (for grade setting or lower limit setting)
- Accessory code 022: 2 sets (for grade setting or lower limit setting)

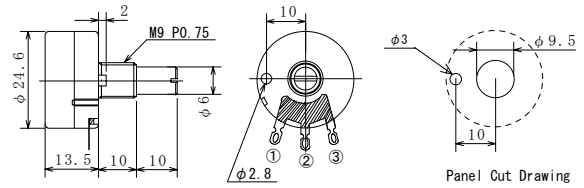

External Variable Resistor (Resistance : 10kΩ Characteristic : B) Unit : mm

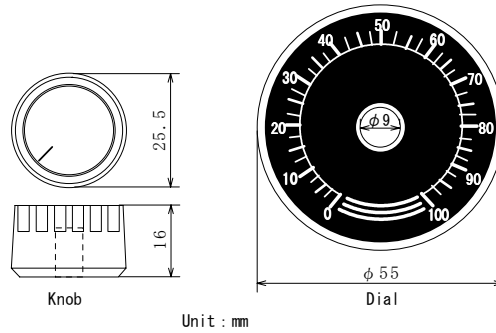

Unit : mm

9-2. Quick-to-burn Fuse (with a fuse holder)

- Accessory code 01A: for 20A (250GH-32)
 - Accessory code 01B: for 30A (250GH-40)
 - Accessory code 01C: for 50A (250GH-63)
 - Accessory code 01D: for 70A (250GH-100)
 - Accessory code 01E: for 100A (250GH-125)
 - Accessory code 01F: for 200A (250GH-315)
 - ※Fuse holder: For 20A ~ 100A 250HL-17
- } Products of K.K.Hinode Denki.

For 200A F-1007-1P × 2p.c.s. Products of K.K.Fujicon.

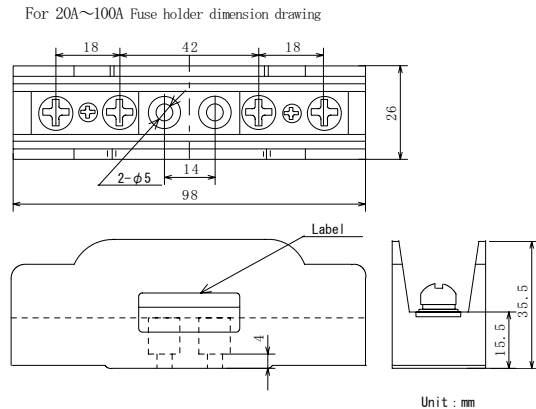

Unit : mm

For 200A fuse holder dimension drawing

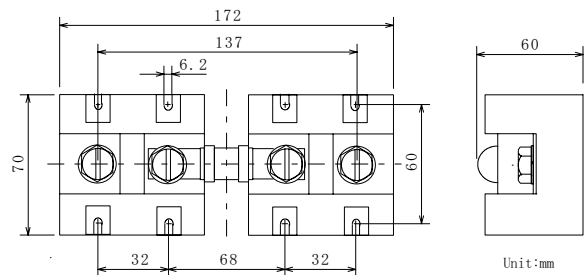



Unit: mm

10. Specification

●Display

(1) Display Type	: Digital display 7-segment red LED 1+3 digits(character height 10mm)
	Operation volume display value 0~100%
	Control input display value 0~100%
	Grade variable resistor setting level 0~100%
	Lower limit variable resistor setting level 0~100%
	Parameters (Refer to Setting)

●Setting

(1) How to Set	: Using the three keys on the front (  ) or an external setting device (accessory, separately sold)
(2) Setting Parameter	<p>C: Option of setting method {Phase control angle/Phase control voltage square/Zero-cross switching cycle operation control}</p> <p>H: Higher limit(grade) setting 0~100%</p> <p>L: Lower setting 0~100%</p> <p>E: Soft-start timer setting 0. 0~25.0s This function is being operated only at the time of power-on</p> <p>U: Slow-up timer setting 0. 0~25.0s</p> <p>D: Slow-down timer setting 0. 0~25.0s</p> <p>r: Option of input method {voltage/Current/Contact/Voltage pulse (SSR drive voltage) } 6types</p> <p>s: Input sampling cycle setting (0~120s) In the case of contact or voltage pulse input Proportional operation responds to 1~120 sec (Set the value as an integral multiple of the proportional frequency of the regulator) Two-position operation responds to 0 sec. setting</p> <p>R: Linear input compensation(lower limit compensation) -5.0~5.0% Being able to set at the time of power-on</p>

●Power Supply

(1) Rated Voltage	: 90~264V AC(free voltage)
(2) Rated Frequency	: 45~65Hz

●Control Input

(1) Types of Input(multi-input)	(Choose by key operation from the following 6 types)
	<p>C: I1-current1 4~20mA DC Receiving impedance approx. 100 Ω</p> <p>I: I2-current2 0~20mA DC Receiving impedance approx. 100 Ω</p> <p>V: V1-voltage 1~5V DC input impedance approx. 500 k Ω</p> <p>V: V2-voltage2 0~5V DC input impedance approx. 500 k Ω</p> <p>C: C1-contact(Contact No-voltage contact or open collector sink load 5V DC 3mA)</p> <p>S: S1-Voltage pulse(SSR drive) 12V DC 3mA</p> <p>※In the case of C1 or S1 input, the regulator responds to both two-position and proportional control. The other input (The following inputs should be specified when ordered. Otherwise, the input is multi type.)</p> <p>V: V3-Voltage3 0~10V DC input impedance approx. 370 k Ω</p> <p>±: ±(1%FS+1digit)</p>
(2) Input accuracy	
(3) Sampling cycle	Contact or voltage pulse input: Two-position control 2ms Proportional control 1~120s Current or voltage input: 2/control power supply frequency

●Output

(1) Current-carrying Capacity	6types: 20A, 30A, 50A, 70A, 100A, 200A
(2) Output Range	: 0~98% or more of an input voltage
(3) Control Method	3types: Phase control angle/phase control voltage square/Zero-cross switching cycle operation control
(4) Lowest Load Current	: 0.5A(in the case of output 98%)
(5) Output response	: One cycle delay of the power supply frequency
(6) Applicable Load	phase Control: Resistive load, Transformer primary control (Magnetic flux density:0.8T Max.) Zero-cross switching cycle operation control: Fixed resistive load
(7) Cooling system	20~100A: Natural air cooling 200A: Forced-air cooling (by cooling fan)

●Accessory (Separately sold)

(1) External Variable Resistor	Higher Limit(grade): Variable Resistor (B 10 k Ω), Knob, Scale Lower limit: Variable Resistor (B 10 k Ω), Knob, Scale
(2) Quick-to-burn fuse	: To be attached externally, with fuse holder

●General Specification

(1) Data Storage	: Non-volatile memory (EEPROM)
(2) Use Environment	Temperature: 0~55°C (Guaranteed range for operation), 0~40°C (Guaranteed range for efficiency) Humidity: Below 90%RH(No condensation) Altitude: 2000m above see level max. category: II Pollution degree: 2
(3) Input Noise Ratio of rejection	: Normal 50dB min. : Common 100dB min.
(4) Insulation Resistance	: Between input and power supply 20M Ω min. 500V DC per minute : Between input and chassis 20M Ω min. 500V DC per minute
(5) Dielectric Strength	: Between input and output 2300V AC per minute : Between input and chassis 1500V AC per minute
(6) External Dimension/Weight	20A: W 50×H192.5×D128mm/approx. 0.6kg 30A: W 50×H192.5×D128mm/approx. 0.7kg 50A: W 60×H192.5×D154mm/approx. 1.2kg 70A: W 110×H192.5×D154mm/approx. 1.8kg 100A: W 155×H192.5×D154mm/approx. 2.3kg 200A: W 111×H302.5×D180mm/approx. 3.4kg

11. Table of display characters, figures, and alphabet

Display characters	Figures	Alphabet	Display characters	Alphabet
1	1	I	J	J
2	2		K	K
3	3		L	L
4	4		l	l
5	5	S	M	M
6	6		N	N
7	7		o	o
8	8		P	P
9	9		Q	Q
0	0	O	r	r
A		A	s	s
B		B	T	T
C		C	t	t
c		c	U	U
d		D	u	u
E		E	V	V
F		F	W	W
G		G	X	X
H		H	Y	Y
h		h	Z	Z
i		i		

12. Main causes of trouble and check points

If there seems to be something wrong with this product, check the following. (Especially at the time of first operation and after setting is changed)

- ①Whether power supply is applied.
- ②Whether wiring is done properly
- ③Whether the type and capacity of the load is appropriate to TVR1
- ④Whether each setting is correctly done
- ⑤Whether they type and level of the control input signal is appropriate

Trouble	Likely cause	Check points
There is no output	<ul style="list-style-type: none"> • No voltage is applied to the control power supply terminal (No.8 and 9) • Grade setting is around 0% or a variable resistor is not connected when B is chosen. • Control input signal is not correct. 	<ul style="list-style-type: none"> • Check voltage between terminal No.8 and 9 with a tester. • Check whether LED is blinking. • Check the set value on the grade setting screen • Check whether a variable resistor is connected when B is chosen and the wiring is done as shown on page 3, 5-2 (2). The scale of the variable resistor is not supposed to be around 0% • Check whether the wiring (page 3, 5-2 (1)), type, level, and polarity of the control input signal is appropriate
Output does not become 0	<ul style="list-style-type: none"> • The lower limit setting is not 0% • Control input signal is big. 	<ul style="list-style-type: none"> • Check the set value on the lower limit setting screen • Check the type, level of the signal and check the controller (Signal source)
There is load voltage though the current is 0A.	<ul style="list-style-type: none"> • Load is open. 	<ul style="list-style-type: none"> • Check the heater and the wiring of the main circuit terminal.
Output is not proportion for input and unstable output.	<ul style="list-style-type: none"> • Un in-phase main circuit (L1-L2) and control power supply terminals (No8 and No9). 	<ul style="list-style-type: none"> • Check the main circuit (L1-L2) and control power supply terminals (No8 and No9). • Refer to page3 Drawing of connection of the main circuit terminals and control power supply terminals.

If there is still something wrong even after inspecting and checking the items mentioned above, there might be some mechanical trouble with the product. Please contact the office or agency of our company.

The contents of this instruction are subject to change without notice.

TOHO ELECTRONICS INC,

Head Office: 1-13-21 Tanashioda, Sagamihara-shi, Kanagawa 229-1125 JAPAN

Phone: +81-42-777-3316 Facsimile: +81-42-777-3751

<http://www.toho-inc.com/english/index.html> overseas@toho-inc.co.jp

PRINTED IN JAPAN T0404

