



Paperless Recorder

TRM-00J



Easier
operation

with
Touch Panel

Large memory
capacity

with SD card
and USB
memory

Features

- Larger touch panel for easier operation
- Reasonable price with six-channel input
- Large memory capacity with SD card and USB memory
- Quickly searches and displays past data
- Equipped with communication function as a standard function (RS485 Modbus/USB2.0 Modbus)
- Equipped with DI/DO function as a standard function
- Recorded data can be verified immediately in CSV format (no specialized software)

TOHO ELECTRONICS INC.

Simple & High - Performance

TRM-00J Paperless Recorder



TRM-00J is a paperless recorder that displays measurement data on an LCD on a real-time basis and saves them into an SD card/USB memory.

Touch panel LCD for easier operation.

Inputs such as thermocouple, RTD and DC voltage/current can be set at user's will for each channel.

It can also redisplay data that has been saved in SD card/USB memory.

Features

● Large touch panel for easier operation

User-friendly recorder with intuitive handling through a 7-inch wide TFT color LCD (800 × 480 dots) touch panel.

● Large memory capacity with SD card and USB memory

Measurement data will first be stored in the internal memory. Data will be written into either SD memory card or USB memory at each file recording cycle or upon stopping of recording. Approximately 2.5 years' worth of data can be collected continuously with the memory capacity of 4GB. (Conditions: 6 input points, 5 seconds of data record cycle, 1 hour of file recording cycle, maximum/minimum record, alarm, and no event such as message)

● Quickly searches and displays past data

Historical trend indication displays the past time data currently recorded as well as data recorded in the past from the file.

● Various displays

Users can switch the display mode between bar graph, trend, and digital on a per-group basis in accordance with the subject of measurement.

● Size

185 (W) × 160 (H) × 188 (D)mm
1.4kg

● Reasonable price with six-channel input

13 kinds of thermocouples, 2 kinds of RTDs, and 8 kinds of DC voltage/current input (shunt resistance required) can be recorded up to 6 points.

● LCD shutoff function

Automatically shuts LCD off if no operation is made to a unit for a specific period. It can prolong the life of the backlight. It can also reduce power consumption while the light is turned off.

● Equipped with communication function as a standard

RS485 Modbus/USB2.0 Modbus is possible.

● Equipped with DI/DO function as a standard

● Recorded data can be verified immediately in CSV format (no specialized software)

Specifications

● Input Specifications

Number of Input Points: 6

Input Circuit: Input Mutual

Insulation Measurement Cycle: 100 ms

Input Type: DC voltage, DC current (shunt resistor is required), Thermocouple and RTD

Switching of Input Type: Set from the setting menu, which will be displayed by pressing the MENU button at the front side of the recorder

Burnout Function: Originally equipped with thermocouple and mV voltage input

Functions can be enabled/disabled.

The record will be made to swing over to the 100% side upon disconnection of the input.

CMRR : 120dB or higher

NMRR : 40dB or higher

Allowable Signal Source Resistance: If burnout function is ON, effect is approximately $0.18 \mu\text{V}/\Omega$. Lead wire resistance of RTD is less than 5Ω .

Input Filter Function: Can be set individually per channel (primary delay filter); time constant can be set with between 0.0 second and 99.9 seconds.

Scaling Function: Available at DC voltage/current input

Scalable Range: ± 32767 Position of Decimal point can be set freely

Unit Symbol: Selectable from preset units

Square Root Operation Function: Performs square root operation for the input value of each channel

●Display Section

Display Section: 7-inch wide TFT color LCD (800×480 dots) touch panel with backlight Brightness can be adjusted.
 LCD may have some picture elements that light at all times or do not light at all. Also, due to the characteristic of LCD, its screen brightness may be uneven. Please note that these are not defects.

Display Color: 16 colors
 Display Language: Select Japanese/English from the setting screen (default is Japanese) Service life of backlight: 30,000 hours (life may be extended if LCD turnoff function is used)
 Display Group: Number of Groups: 8
 No. of Channels: Display setting of up to 6 channels per group are possible.
 Real-time Trend Display: Displays the current measurement data in the form of graph
 Direction: Vertical or horizontal

●Operation Button

Number of Buttons: 3 (can be operated by opening the cover at the lower portion of the front side of the recorder)
 Function: REC: Starts/stops the recording
 MENU: Displays setting screens
 FUNC: Executes the preassigned function

●Recording Function

External Memory: SD Memory Card (Compatible with SD/SDHC standards Class 6 and higher)
 USB Memory (Compatible with USB 2.0 standards)
 Internal Memory: 4GB

Memory Capacity: SD Memory Card: SD Standard: Max. 2GB
 SD Memory Card: SDHC Standard: Max. 32GB
 USB Memory: Max. 32GB

Recording Method: Starts the recording by pressing the REC button.
 New file with a new file name will be created whenever the recording starts.

Main Memory: Records each channel data for the 8 main record groups that were set in the Display Group.
 Contents of the record are trend data, event data, and message data.

Data Recording Cycle: Can select the data recording cycle between 100msec. and 60 min.
 File Recording Cycle: Recorded data will first be stored in the internal memory. Data will be written into either the SD memory card or USB memory at each file recording cycle or upon stopping of recording. Allows the user to select the data saving period of one record file between 10 minutes and 1 year.
 Trend Data: Among measurement data sampled at the measurement cycle, the average value, moment value, or min/max measurement value will be saved.
 Other Recorded Data: Alarm information and message records

●Alarm Functions

No. of Settings: Can set up to 4 points per channel
 Alarm Type: Maximum Limit, Minimum Limit, Abnormal Data
 Display: Shows at the digital display section when the alarm occurred.
 Displays in red at the right frame of the horizontal trend display screen and at the lower frame of the vertical trend display screen.

Can select between display/nondisplay of numeric value and scale
 Historical Trend Display: Displays the past measurement data in the form of graph
 Direction: Vertical or horizontal
 Can select between display/nondisplay of numeric value and scale
 Bar Graph Display: Displays the current measurement data in the form of a vertical bar graph
 Digital Display: Displays the current measurement data (value) in an enlarged size
 Displays the alarm number.
 Event History: Displays alarm history, message data, and self-diagnosis
 Parameter Display/Setting: Displays the setting data by the front menu button
 Tag Display: Number of Displayable Characters: Max. 11 characters (Number of Inputtable Characters: 29)

Recording Capacity: Recording is possible for time durations listed below under the following conditions.
 [Condition] —No. of Input Points: 6
 – Recording Type: Record maximum/minimum value
 – No occurrence of an event, such as an alarm and a message

SD Memory Card /USB Memory	4GB				
File Saving Cycle	1 hr.			1 day	
Data Recording Cycle	1 sec.	2 sec.	5 sec.	10 sec.	1 min.
Recording Capacity	0.5 yr.	1.0 yr.	2.5 yr.	5.0 yr.	30.0 yr.

※ Recording beyond the product’s life shall not be guaranteed.

Memory Usage Capacity Display: Displays the usage of internal memory, SD memory card, or USB memory in % at the screen of the recorder. When the recording area of SD memory card/USB memory is full, data will be recorded into the internal memory instead of the SD/memory card by overwriting the old data. When the recording area of the internal memory is full, the user has the option to either stop the recording or continue with the recording by deleting records from the oldest data.
 Data Format: CSV (CSV format allows the data to be read directly by MS Excel and other application software)
 CSV Format: Approximately 120 bytes per sample (upon inputting 6 channels and recording max./min.)
 Format: FAT16/FAT32

Hysteresis: Can be set with 0.0 to 3276.7°C or 0 to 32767 (digit)
 Alarm Output: Common Alarm Output 1 point (Open collector output)
 Contact Rating: 30V DC 20mA/point

●Power Supply Section

Rated Power Voltage: 100 to 240V AC
Operation Voltage Range: 85 to 250V AC
Power Frequency: 50/60Hz (Shared)
Power Consumption: Approx. 32VA (AC250V)

●Structure

Installation Method: Panel Embedded Mounting (Vertical Panel)
Installation Posture: The rear side 0 to 30 degrees, the right and left horizontal.
Panel Thickness: 2 to 7mm
Material: PC-ABS for both case and bezel

Color: Grey
Dimensions: 185 (W) × 160 (H) × 188 (D) mm
Weight: 1.4kg
External Terminal Board: M4 screw terminal

●Normal Operation Condition

Power Voltage: 85 to 250V AC
Ambient Temperature: 0 to 50°C
Ambient Humidity: 20 to 80%RH

Warm-up Time: 30 minutes or more from the time the power is turned ON

●Others

Clock: With calendar function (calendar year)
Accuracy of ± 3.8 ppm or less (Monthly error: Approx. 10 seconds) Provided, however, that the error that may occur upon turning the power ON/OFF shall not be considered.
Memory Backup: Parameters will be saved in the internal flash memory
Clock will be backed up by the built-in lithium battery (Battery life when not in use: Approx. 5 years)

Insulation Resistance: 20M Ω or higher (between each terminal and ground at 500V DC)
Voltage Endurance: Between Input Terminals . . . 500V AC for 1 minute
Between power supply terminal and ground . . . 2000V AC for 1 minute
Between input terminal and ground . . . 500V AC for 1 minute

●Compatible Standards

Dustproof and Waterproof Standard: Based on JIS C0920 IP54 (Front Panel)

●Transportation and Storage Conditions

Temperature: -10 to 60°C (without freezing and condensation)
Humidity: 5 to 90%RH

Vibration: 10 to 60Hz 2.45m/s² or less
Impact: 249m/s or less (while inside the package)

●Additional Functions

■Communication

Communication Standard: RS-485
Communication Function: Electrical Specifications: Based on EIA RS-485
Protocol: Modbus RTU, Modbus ASCII, TOHO
Communication Method: Two-wire half-duplex: Start-stop synchronization
Data Type: Data Length: 7, 8bits Stop Bit: 1, 2bit
Parity: Odd, even, none
Communication Speed: 2400, 4800, 9600, 19200, and 38400bps
Maximum Number of Units that Can Be Connected: 32 units including master (multidrop)
Communication Distance: Up to 500m (Total extension)

Connection Type: M4 Terminal board
Communication Standard: USB 2.0
Communication Function: Electrical Specifications: Based on USB-CDC
Protocol: Modbus RTU, Modbus ASCII, TOHO
Communication Method: Two-wire half-duplex: Start-stop synchronization
Data Type: Data Length: 7, 8bits
Stop Bit: 1, 2bit
Parity: Odd, even, none
Communication Speed: 2400, 4800, 9600, 19200, and 38400bps
Maximum Number of Units that Can Be Connected: One to one
Maximum Communication Distance: 3m
Connection Type: USB Micro B terminal

■DI Input/DO Output

DI: Nonvoltage Contact Input (9 points), common
Photocoupler-driven 5V DC Approx. 9mA/point
The following controls are possible by contact input (ON/OFF pulse time 500ms or greater):
① Start/stop recording
② Set messages
③ LCD backlight ON/OFF
Connection Type: Connector (40 pins, DI/DO mixed)

DO: Open Collector Output (12 points) common
Contact Rating: 30V DC 20mA/point Can be designated as an alarm output
Connection Type: Connector (40 pins, DI/DO mixed)

Measuring Range

Type	Measuring Range	Maximum Resolution	Accuracy Rating (For FS)	Remark
mV	-10.00 to +10.00	10 μ V	$\pm (0.1\% + 1\text{digit})$	*1 0 to 200°C : $\pm (0.15\% + 1\text{digit})$ *2 0 to 400°C : 4% 400 - 800°C : $\pm (0.15\% + 1\text{digit})$ *3 $\pm (0.2\% + 1\text{digit})$ *4 0 to 300°C : $\pm (0.15\% + 1\text{digit})$ 300 to 800°C : $\pm (0.8\% + 1\text{digit})$
mV	0.00 to +20.00	10 μ V		
mV	0.00 to +50.00	10 μ V		
V	-1.000 to +1.000	1mV		
V	-10.00 to +10.00	10mV		
V	-0.00 to +10.00	10mV		
mA	4.00 to 20.00	0.01mA		
K	-200.0 to +1372.0	0.1°C	$\pm (0.1\% + 1\text{digit})$ Provided that -200.0 to 0.0°C is $\pm (0.15\% + 1\text{digit})$	
J	-200.0 to +1200.0	0.1°C		
T	-200.0 to +400.0	0.1°C		
E	-200.0 to +1000.0	0.1°C		
R *1	-50.0 to +1768.0	0.1°C		
S *1	-50.0 to +1768.0	0.1°C		
B *2	0.0 to +1800.0	0.1°C		
N	-200.0 to +1300.0	0.1°C		
U	-200.0 to +400.0	0.1°C		
L	-200.0 to +900.0	0.1°C		
WRe5-26 *3	-0.0 to +2300.0	0.1°C		
PR40-20 *4	-0.0 to +1880.0	0.1°C		
PL II	-0.0 to +1390.0	0.1°C	$\pm (0.1\% + 1\text{digit})$ Provided that -200.0 to 0.0°C is $\pm (0.15\% + 1\text{digit})$	
Pt100	-200.0 to +850.0	0.1°C	$\pm (0.1\% + 1\text{digit})$	
JPt100	-200.0 to +510.0	0.1°C		

※ Connect shunt resistor upon current input.

Thermocouple Standard: K, J, T, E, R, S, B, and N are JIS C 1602-2015; U and L are DIN; and WRe-26 and PR40-20 are ATSM

RTD: Pt100 and JPt100 are JIS C1604-2013

[Caution]

Applicable under basic conditions. Accuracy of the reference junction compensation will not be included in the digital display accuracy.

Accuracy of the reference junction compensation shall be the following:

• Accuracy of the reference junction compensation: R, S, B, PR40-20, WRe5-26: $\pm 1^\circ\text{C}$

K, J, T, E, N, U, L, PL II : $\pm 0.5^\circ\text{C}$

• Basic Conditions: Ambient Temperature: $23^\circ\text{C} \pm 2^\circ\text{C}$

Ambient Humidity: $55 \pm 10\%$ RH

Power Voltage: 85 to 250V AC

Power Frequency: 50/60Hz $\pm 1\%$

Warm-up Time: 30 minutes or more from the time the power is turned ON

External Size

Unit: mm

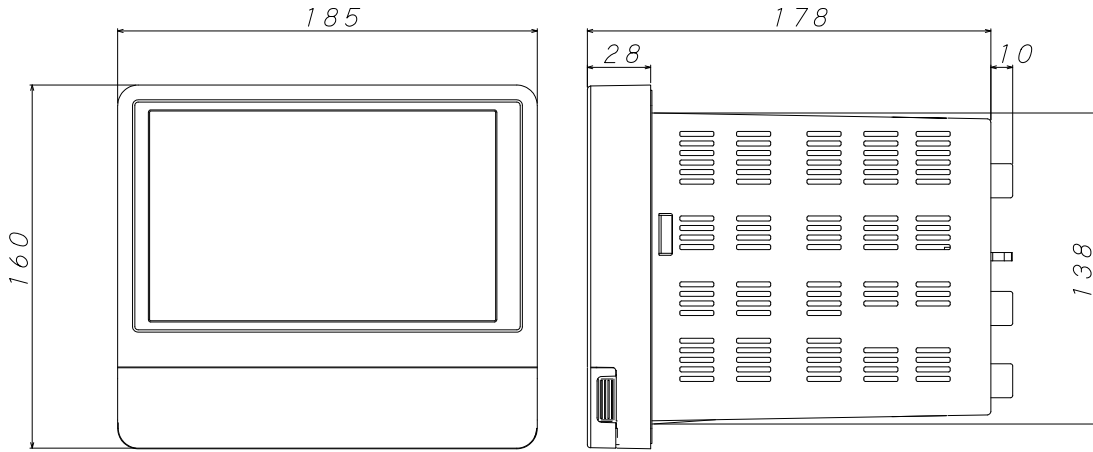

Dimensions of Panel Cut (Unit: mm)

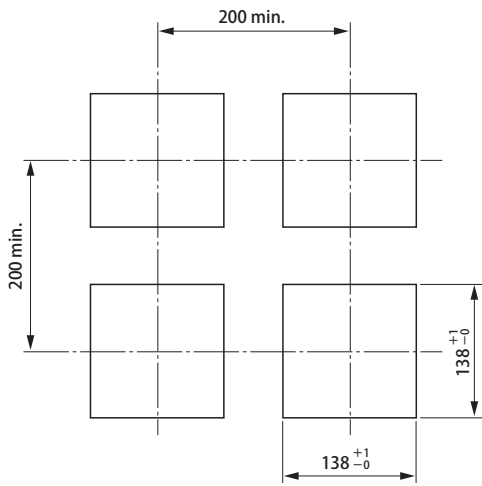

Terminal Layout

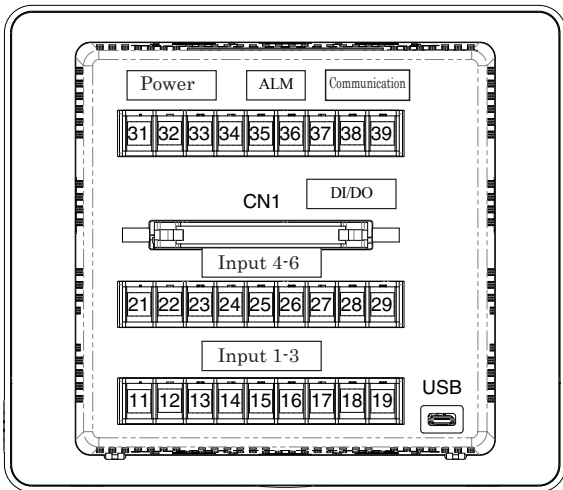

[Terminal Block Array]

DI: Nonvoltage Contact Input (9 points), common
 DO: Open Collector Output (12 points), common

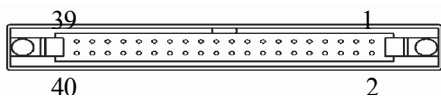

Pin No.	Signal Name	Pin No.	Signal Name
1	DI1	21	DO1
2	DI2	22	DO2
3	DI3	23	DO3
4	DI4	24	DO4
5	DI5	25	DO5
6	DI6	26	DO6
7	DI7	27	DO7
8	DI8	28	DO8
9	DI9	29	DO9
10	NC	30	DO10
11	NC	31	DO11
12	NC	32	DO12
13	DI_COM	33	DO_COM
14	DI_COM	34	DO_COM
15	DI_COM	35	DO_COM
16	DI_COM	36	DO_COM
17	DI_COM	37	DO_COM
18	DI_COM	38	DO_COM
19	DI_COM	39	DO_COM
20	DI_COM	40	DO_COM

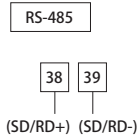
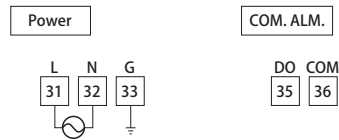

Note: Attach the terminator at the end station.

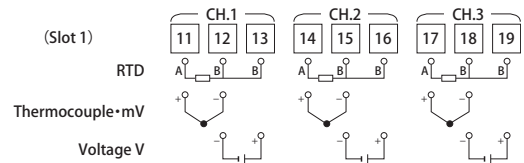
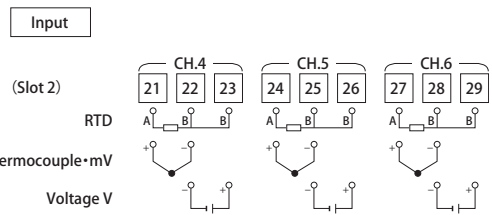

Product Model

TRM-00J

Items Included

Item Name		Qty.
Main Unit		1 unit
Metal Fittings for the Panel		1 set
CD-ROM	Operation Manual	1 sheet
Panel Packing		1 piece
O-ring for Waterproofing		1 piece

(Note) SD memory card is sold separately.

Items Sold Separately

Item Name	Format
Shunt Resistance for DC Current Input	HMSU3081A11
Terminal Resistance for RS-485 Communication	WMSU0303A01
DI/DO Cable (3m)	WMSU0468A02



TOHO ELECTRONICS INC.

Head Office: 2-4-3 Nishihashimoto, Midori-Ku, Sagami-hara, Kanagawa 252-0131 Japan
Phone: +81-42-700-2100 FAX: +81-42-700-2112
E-Mail: overseas@toho-inc.co.jp
Web site: <https://www.toho-inc.com/english/>



Warning

This product is designed for use in general industrial equipment. (Do not use this product with equipment that may greatly affect the human life)



Caution

- Please read the operation manual carefully for proper and safe usage of the product.
- In case the trouble of this product may cause damage or loss to system or property, take necessary safety measure to prevent the accident before using this product.

● Specifications and rated values in this catalog are subject to change without notice
Note: The color printed in this catalog may be different from actual color.